

294/560

Dimensions

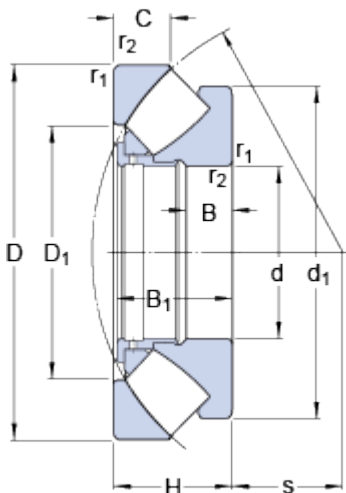

d	560	mm
D	980	mm
H	250	mm
d ₁	≈ 890	mm
D ₁	≈ 727	mm
B	99	mm
B ₁	241	mm
C	122	mm
s	328	mm
r _{1,2}	min. 12	mm

Abutment dimensions

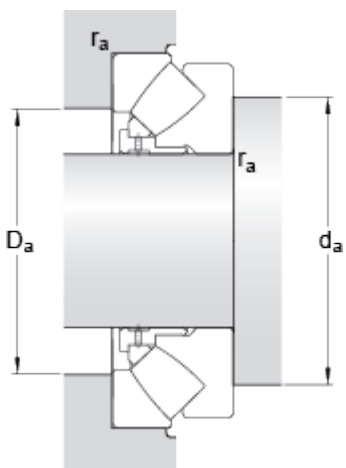

d _a	min. 770	mm
D _a	max. 850	mm
r _a	max. 10	mm

Calculation data

Basic dynamic load rating	C	12000	kN
Basic static load rating	C ₀	51000	kN
Fatigue load limit	P _u	3550	kN
Reference speed		300	r/min
Limiting speed		560	r/min
Minimum axial load factor	A	250	

Mass

Mass bearing		810	kg
--------------	--	-----	----